



W/BF

BUSHING



WBF Spare Parts LTD
www.wbfparts.com
E-mail: info@wbfparts.com

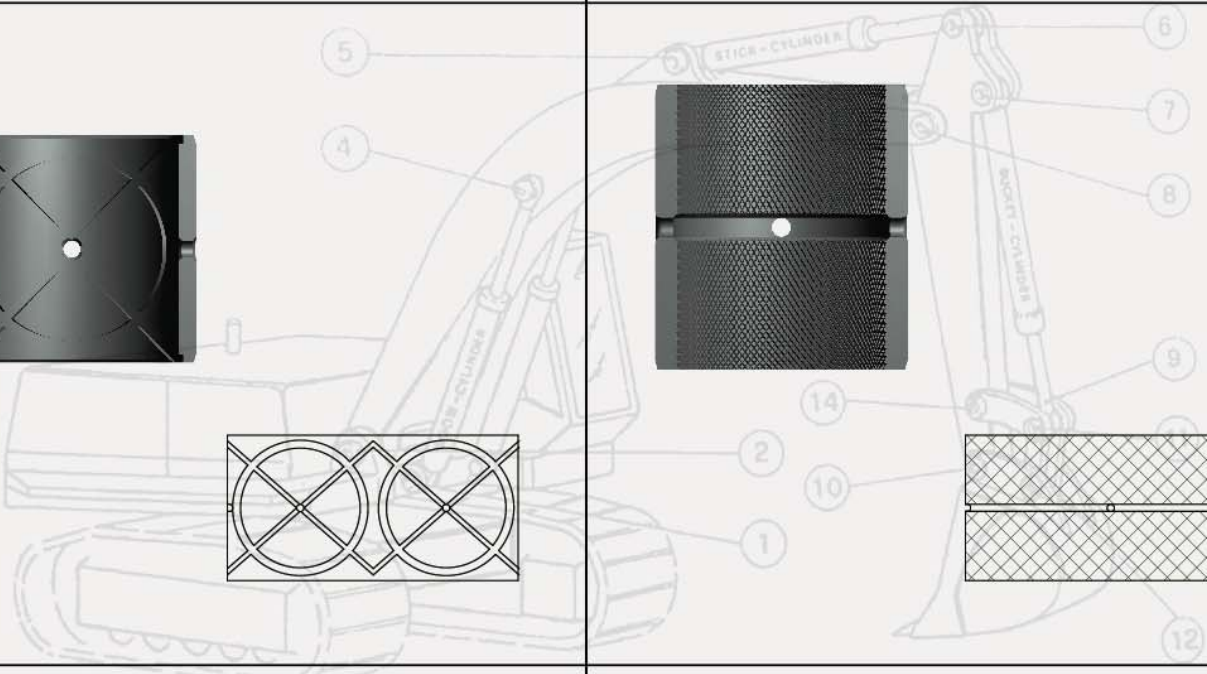
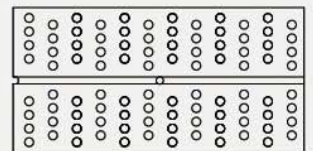
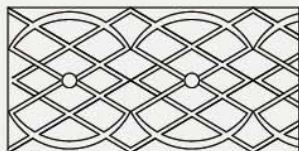
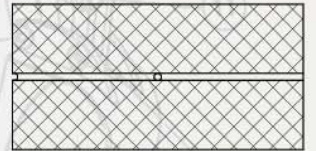
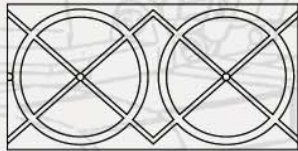
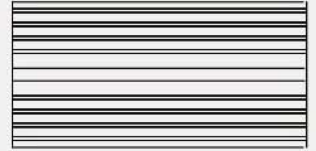
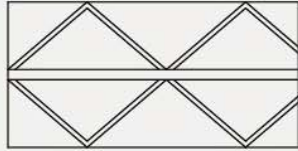

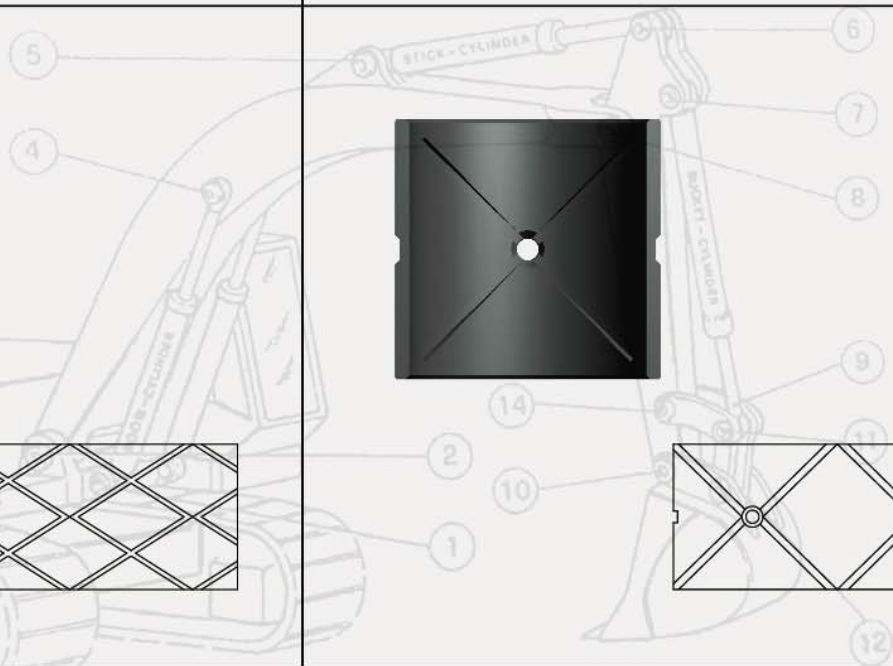
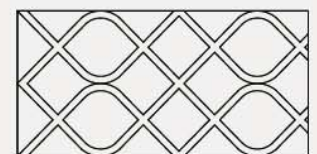
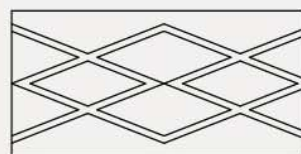
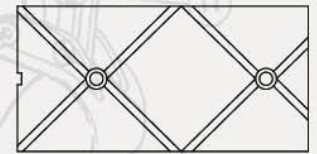
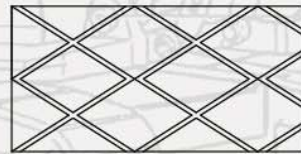
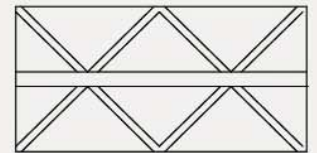
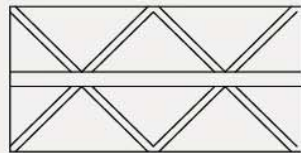



WBF BUSHING >>>

PART No.	Machine	
990718	312 6BL	312 6GK
990721	311B 8GR	312 6BL
1024560	416B 8SG	416C 1AR1 UP
1066872	307C_BCM	307C_BNE
1164825	416C 1KR1 UP	416C 1LR1 UP
1633749	308C_	308C_CPE
2580768	D8N_5TJ	D8N_9TC
1J2087	816F_5FN	D7
1J2192	824G_AWW	824H_ASX
1U0738	824H_ASX	D7
1U2182	D8	D8L
1V6934	988B_50W	988F_2ZR
1V7036	988B_	988B_50W
1V7098	225_51U	225_76U
1V8241	980F 4RN	980F 8JN
1V8242	930G TFW	980F 4RN
1V9148	928G DJD	928G WLG
2D4187	112F_89J	120B_10R
2G8607	14M_B9J	14M_R9J
2G8624	120H_5FM	140H_2ZK
2G8631	120G 11W	120G 4HD
2G8635	14M_B9J	14M_R9J
2G8661	120G_11W	120G_1LK
2G8793	120M_B9C	140M_B9D
2J8489	D5B 22X	D5B 46X
2K4375	966C_25U	966C_30K
2K4442	924G_DDA	924G_RBB
2K4502	930 79J	920 41J
2K4505	938G_CRD	938G_PHN
2K4507	12E 17K	12E 21F
2K4509	930 79J	12F_13K
2K4510	950_18R	950_31K
2K4513	930 79J	12F 13K
2K7647	944A_43A	950_
2V0706	215 14Z	215 61Z
2V0707	215 14Z	215 61Z
2V4876	944A_43A	944A_70A
3G2797	924GZ_DFZ	926E 8NB
3G4292	235C_2PG	235C_4DG
3G4704	910G_	910G_B9X
3G5111	950F_5SK	950F_8TK
3G5999	D6R_AAX	D7R_AEC
3G7570	926E 8NB	910F_
3G7624	950G_3JW	950G_AXX
3G8051	D10N	D10N_
3G8052	844H_BTW	D10N
3G8779	345B_AGS	950B/E 22Z
3G9598	D6R_5LN	D6R_AAX
3J2373	615C_2XG	623F_5SG
3J3953	621F_4SK	621F_5JK
3J6167	D-7-G	D5H 9HC

PART No.	Machine	
3J6412	621E	621F
3J6442	D5H 9HC	D7
3J6484	D10	D10N
3J9133	613 71M	613B_72M
3K2144	922B_	922B_59A
3T0996	D6H 1FJ	D6H 1KD
3T0997	D6H 1FJ	D6H 1KD
3T4307	434E_FSH	434E_SEF
3T4308	906_6ZS	906_MER
3W4362	928F 2XL	928F 7YM
3W8239	315C_CJC	320B 9KR
4D1192	966G_3SW	966G_ANZ
4I0453	315 3ZM	315 4YM
4J2379	983_38K	D10N
4J5695	615C_2XG	621F_4SK
4J6167	950E_63R	D5H 1DD
4J6374	245 84X	245 95V
4K8734	140M_B9D	140M_B9M
4T0370	930G TFW	631E_1AB
4T7351	416 5PC 1200 UP	416_5PC
4V1901	950H_K5K	950H_M1G
4V2873	924H_PED	936 33Z
4V2879	924G EEB	924G RBB
4V2883	928G DJD	928G WLG
4V4444	926E 8NB	906_6ZS
4V4445	926E 8NB	315B_3AW
4V8519	966D 35S	966D 94X
4V8520	930G TFW	330 8FK
4V8631	924GZ_DFZ	916 2XB
4V8639	924F 6MN	924G EEB
4V8643	924F 6MN	924GZ_DFZ
4V8673	320B 5BR	966D 94X
4V8674	924G EEB	924G RBB
4V8675	307C_BCM	308C_KCX
5C6691	215 14Z	215 2XC
5C6738	225 51U	225 61X
5C6739	225 51U	225 61X
5D1705	112F_89J	120B_10R
5D4541	12F_13K	12F_33K
5J1192	826H_AWF	950E_63R
5J1193	824G_AWW	824H_ASX
5J7876	930 79J	930 41K
5K0984	120G 11W	120G 4HD
5K7041	941B_70H	941B_80H
5K7995	572R_DSC	930 8CB
5T1242	613B_38W	613B_72M
5T1243	613C II	613C
5T1244	613C	
5V1007	938G_B9Y	938G_CRD
5V1386	950B/E 22Z	950B/E 31R
5V1874	924G_DDA	924H_HXC



PART No.	Machine	
6A7099	215 14Z	215 61Z
6A7129	215 14Z	215 61Z
6E3535	311 9LJ	311B 2LS
6J2242	930 71H	930 79J
6J6043	621F_4SK	627G_DBD
6J7175	920 41J	920 62K
6K2694	920_	920_41J
6K2899	236B_HEN	252B_SCP
6K3194	955K_31J	955K_48H
6K4076	140H_2ZK	140H_CCA
6K4148	236B_HEN	246B_PAT
6K4185	120H_5FM	140H_5HM
6K4189	926E_4NB	926E_94Z
6K6044	930 79J	525B_3KZ
6S3459	910 40Y	910 41Y
6S3463	910 40Y	910 41Y
6S3465	910 40Y	910 41Y
6W8583	215 14Z	215 57Y
6Y5812	D7H 2RG	D7H 3XG
6Y6134	527_4NS	527_BDW
6Y6236	527_3DS	527_4NS
7J6250	924G_DDA	930G_TWR
7J9344	320B 4NR	924G_DDA
7J9346	924G_DDA	924H_HXC
7J9351	906_6ZS	906_MER
7J9365	966B_57H	966B_75A
7J9366	966B 75A	966B_57H
7J9374	955L 13X	955L 64J
7J9682	930 71H	320B 4NR
7J9688	924G_DDA	924G_RBB
7J9694	24H_7KK	24M
7J9699	930 71H	140H_2ZK
7J9708	14G 96U	14G_96U
7J9731	966B 75A	966C 30K
7J9842	930 71H	920 41J
7J9884	120G 87V	12G 61M
7K0084	910G_	910G_B9X
7K0085	944A_43A	950 31K
7K0086	944A_43A	950 31K
7K0087	914G_9WM	950 31K
7K0088	930 71H	320C_AMC
7K7195	930 79J	910F_2SS
7K9528	924G_DDA	930G_TWR
7K9546	924K_PWR	930K_RHN
7K9547	941B_16U	941B_70H
7K9549	938F_1KM	938G_4YS
7K9572	916 2XB	916 5KC
7K9573	955K_48H	955K_61H
7K9576	955K_31J	955K_48H
7K9589	920 41J	920 62K
7K9590	920 41J	920 62K

PART No.	Machine	
7K9591	920 41J	920 62K
7K9592	312C_CAE	312C_CBA
7K9593	320B 4NR	320B_4NR
7K9601	930 71H	320C BDC
7K9602	930 71H	320C BDC
7K9603	930 71H	518_95U
7K9604	930 71H	930 41K
7K9638	966C 25U	966C 30K
7K9639	320 1XM	320B 4NR
7K9640	950_43J	950_81J
7K9642	320C BDC	320C BER
7K9643	966B_57H	966B_75A
7K9644	320C AMC	320C BDC
7K9686	980 89P	988 87A
7P1576	926E_4NB	926E_94Z
7P3454	924G EEB	924G RBB
7P3466	924G EEB	924G RBB
7P6596	953C_2ZN	953C_BBX
7V8632	950G_3JW	950G_AXX
7Y2395	315 3ZM	315 4YM
7Y2396	315 3ZM	315 4YM
7Y2397	320LN 4RM	322B 7WL
7Y3428	311 9LJ	311B 2LS
7Y6389	320 2DL	320L 9KK
7Y6607	320 2DL	320L 9KK
7Y6608	320 1KL	320 1TL
8D8829	615C_2XG	615C_9XG
8E6752	D6R_5LN	D6R_AAX
8E6755	D7E 95A	D7F 93N
8E6756	D7E 95A	D7F 93N
8G0931	943_03Y	943_04Z
8G4022	910H_	910H_SAT
8G8311	D6H 1KD	D6H 2TG
8J0201	615C_9XG	621F_4SK
8J5778	16M	930G_TWR
8J6384	120H_5FM	120K_JAP
8J7596	615C_2XG	615C_9XG
8J9910	120H_5FM	120K_JAP
8K0533	225 51U	225 61X
8K2896	235 32K	235 62X
8K5757	944A_43A	944A_70A
8P0420	980G_2KR	980G_9CM
8P7598	D10N	D10N_2YD
8R7336	215C 4HG	215D 9TF
8W4167	14G 96U	14G_96U
9J1142	631D_28W	631D_29W
9J1175	D10	D11N
9J5875	980F 4RN	980F 8JN
9J7078	966D/E 2FD	966D/E 35S
9J7100	966D/E 2FD	966D/E 35S
9J9427	621 23H	621B 35V

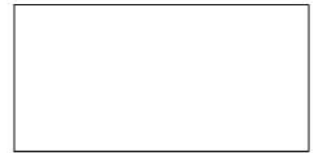
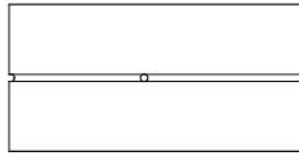

PART No.	ID	OD	Height	TYPE
B035045040BCD	35	45	40	BCD
B045055045BCD	45	55	45	BCD
B045055050BCD	45	55	50	BCD
B050060050BCD	50	60	50	BCD
B060070060BCD	60	70	60	BCD
B060075060BCD	60	75	60	BCD
B060075065BCD	60	75	65	BCD
B060075080BCD	60	75	80	BCD
B060075090BCD	60	75	90	BCD
B065080060BCD	65	80	60	BCD
B065080080BCD	65	80	80	BCD
B070085050BCD	70	85	50	BCD
B070085060BCD	70	85	60	BCD
B070085070BCD	70	85	70	BCD
B070085075BCD	70	85	75	BCD
B070085085BCD	70	85	85	BCD
B070085090BCD	70	85	90	BCD
B080095070BCD	80	95	70	BCD
B080095080BCD	80	95	80	BCD
B080095085BCD	80	95	85	BCD
B080095090BCD	80	95	90	BCD
B080095100BCD	80	95	100	BCD
B080095105BCD	80	95	105	BCD
B080095110BCD	80	95	110	BCD
B080095120BCD	80	95	120	BCD
B080095125BCD	80	95	125	BCD
B090106090BCD	90	106	90	BCD
B090106100BCD	90	106	100	BCD
B090106110BCD	90	106	110	BCD
B090106130BCD	90	106	130	BCD
B100116100BCD	100	116	100	BCD
B100116110BCD	100	116	110	BCD
B100116140BCD	100	116	140	BCD
B110130100BCD	110	130	100	BCD
B110130110BCD	110	130	110	BCD
B110130130BCD	110	130	130	BCD
B120140120BCD	120	140	120	BCD
B130154130BCD	130	154	130	BCD
B130154140BCD	130	154	140	BCD

PART No.	ID	OD	Height	TYPE
B035045040A	35	45	40	A
B035045045A	35	45	45	A
B035045050A	35	45	50	A
B035045055A	35	45	55	A
B038048032A	38	48	32	A
B038050035A	38	50	35	A
B040050040A	40	50	40	A
B040050045A	40	50	45	A
B040050050A	40	50	50	A
B040050055A	40	50	55	A
B040050060A	40	50	60	A
B040050065A	40	50	65	A
B045055040A	45	55	40	A
B045055045A	45	55	45	A
B045055050A	45	55	50	A
B045055055A	45	55	55	A
B045055060A	45	55	60	A
B050060040A	50	60	40	A
B050060045A	50	60	45	A
B050060048A	50	60	48	A
B050060050A	50	60	50	A
B050060055A	50	60	55	A
B050060060A	50	60	60	A
B050060065A	50	60	65	A
B050060075A	50	60	75	A
B060070054A	60	70	54	A
B060070093A	60	70	93	A
B060070105A	60	70	105	A
B070080086A	70	80	86	A
B070080104A	70	80	104	A
B080090065A	80	90	65	A
B080090084A	80	90	84	A
B080090095A	80	90	95	A
B080090109A	80	90	109	A
B090100083A	90	100	83	A
B090100113A	90	100	113	A
B090100128A	90	100	128	A
B090100133A	90	100	133	A
B120130113A	120	130	113	A

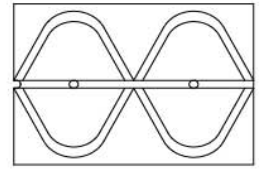
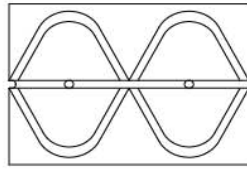

PART No.	ID	OD	Height	TYPE
B060075060CDE	60	75	60	CDE
B060075065CDE	60	75	65	CDE
B060075080CDE	60	75	80	CDE
B065078030CDE	65	78	30	CDE
B065078048CDE	65	78	48	CDE
B065080060CDE	65	80	60	CDE
B065080070CDE	65	80	70	CDE
B065080080CDE	65	80	80	CDE
B070085040CDE	70	85	40	CDE
B070085050CDE	70	85	50	CDE
B070085060CDE	70	85	60	CDE
B070085070CDE	70	85	70	CDE
B070085075CDE	70	85	75	CDE
B070085080CDE	70	85	80	CDE
B070085085CDE	70	85	85	CDE
B070085086CDE	70	85	86	CDE
B070085090CDE	70	85	90	CDE
B070085125CDE	70	85	125	CDE
B075090060CDE	75	90	60	CDE
B075090065CDE	75	90	65	CDE
B075090075CDE	75	90	75	CDE
B080095050CDE	80	95	50	CDE
B080095060CDE	80	95	60	CDE
B080095062CDE	80	95	62	CDE
B080095070CDE	80	95	70	CDE
B080095072CDE	80	95	72	CDE
B080095075CDE	80	95	75	CDE
B080095080CDE	80	95	80	CDE
B080095085CDE	80	95	85	CDE
B080095090CDE	80	95	90	CDE
B080095095CDE	80	95	95	CDE
B080095100CDE	80	95	100	CDE
B080095105CDE	80	95	105	CDE
B080095110CDE	80	95	110	CDE
B080095120CDE	80	95	120	CDE
B080095125CDE	80	95	125	CDE
B085100070CDE	85	100	70	CDE
B085100080CDE	85	100	80	CDE
B085100090CDE	85	100	90	CDE
B090105070CDE	90	105	70	CDE
B090105090CDE	90	105	90	CDE
B090105096CDE	90	105	96	CDE
B090105100CDE	90	105	100	CDE
B090105110CDE	90	105	110	CDE
B090105130CDE	90	105	130	CDE
B090106089CDE	90	106	89	CDE
B090106090CDE	90	106	90	CDE
B090106100CDE	90	106	100	CDE

PART No.	ID	OD	Height	TYPE
B090106110CDE	90	106	110	CDE
B090106130CDE	90	106	130	CDE
B090110090CDE	90	110	90	CDE
B095110080CDE	95	110	80	CDE
B095110095CDE	95	110	95	CDE
B100110124CDE	100	110	124	CDE
B100110138CDE	100	110	138	CDE
B100115074CDE	100	115	74	CDE
B100115106CDE	100	115	106	CDE
B100116100CDE	100	116	100	CDE
B100116110CDE	100	116	110	CDE
B100116120CDE	100	116	120	CDE
B100116140CDE	100	116	140	CDE
B100130100CDE	100	130	100	CDE
B110125100CDE	110	125	100	CDE
B110125116CDE	110	125	116	CDE
B110125140CDE	110	125	140	CDE
B110130100CDE	110	130	100	CDE
B110130110CDE	110	130	110	CDE
B110130120CDE	110	130	120	CDE
B110130130CDE	110	130	130	CDE
B120135130CDE	120	135	130	CDE
B120140110CDE	120	140	110	CDE
B120140120CDE	120	140	120	CDE
B120140130CDE	120	140	130	CDE
B130154130CDE	130	154	130	CDE
B130154140CDE	130	154	140	CDE
B130155130CDE	130	155	130	CDE
B140164120CDE	140	164	120	CDE
B140164140CDE	140	164	140	CDE
B150180150CDE	150	180	150	CDE

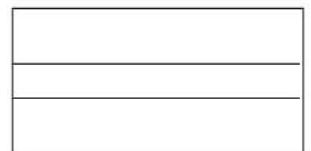

PART No.	ID	OD	Height	TYPE
B060075060B	60	75	60	B
B070085070B	70	85	70	B
B070085080B	70	85	80	B
B080095080B	80	95	80	B
B080095085B	80	95	85	B
B110125105B	110	125	105	B

WBF



BUSHING

Machining range of bearing sleeve			
I.D.	O.D.	Width	Thickness
Φ4~20	Φ6~25	5~30	≧ 1.5
Φ20~45	Φ25~53	10~120	≧ 2.5
Φ45~120	Φ53~250	10~180	≧ 4
Φ120~180	Φ132~250	10~180	≧ 6
Φ180~230	Φ196~250	10~180	≧ 8

Machining precision of bearing sleeve			
Item	Tolerance mm	Roughness μm	
O.D.	±0.013	0.8	
I.D.	±0.02	0.8	
Width	±0.05	1.6	

WBF Spare Parts LTD is a dynamic enterprise specialized in supplying a wide range of replacement parts for earthmoving machines.

WBF has the purpose of providing an excellent service to meet the customer needs with the utmost professionalism and reliability.

WBF is modern, facing the future with a great capability in offering a line of products of top quality parts to assure good results with attractive and competitive prices.

Product Details Description

WBF steel bushings are excellent for low speed/high load, or pivot applications. These hardened steel bushings are commonly used to protect housing from premature wear due to the friction with a pin.

WBF steel bushings undergo casehardening and tempering treatment with casehardening depth of 0.8-1 mm and hardness HRC 58-62. And common materials are: 45Cr; 40Cr; 20CrMn-Ti; 20CrMn.

When the bush undergoes this special thermal treatment to fully enhance its characteristics, it is suitable for use in workplaces requiring excellent resistance to wear and tear and seizing. Its performance is high, offers a longer service life and greasing intervals of up to a max of 550h.

Steel bushing assemblage

The use of steel bushings requires tight fitting to avoid any movement.

Steel bushings can be assembled in various ways, for example:

1. Put the steel bushing under the press using a tool.
 2. Dip the steel bushing in nitrogen, the low temperature will shrink the steel bushing to fit in its seat.
- Once reheated, it will be locked on the outer diameter.